

Thermoscreed Underfloor Heating

Loose Wire In Screed
Heating Cable

Installation Guide

Thank you for your purchase

Thank you for choosing a Thermogroup product. Our commitment to simple, honest, on-time quality service ensures that we are here to help throughout every stage of your project from idea to installation and, most importantly, after sales support.

This document will provide a step-by-step guide to a perfect installation as well as details on the warranty and how to get technical support should you need it.

To ensure a safe, hassle-free installation to be proud of, please take the time to read this guide in full before you start. We've taken the time to highlight potential pitfalls and common errors to avoid and get the job done!

Thermoscreed is covered by a lifetime warranty, subject to terms and conditions. Be sure to keep the receipt as proof of purchase, this will be required to validate your Lifetime warranty.

Please complete the Customer Handover section on page 19 in full so that your customer has all the information they need to complete the online warranty form and register their Thermoscreed Lifetime Warranty.

If you have any questions about your Thermoscreed Underfloor Heating or any of our other products call our technical support team on 1300 989 464. We will do our best to find a solution and will always give that little bit extra...

Thanks again for choosing a Thermogroup product.

Thermogroup
PO Box 822
19 Ridley Ave
Leeton NSW 2705

1300 989 464
sales@thermogroup.com.au
www.thermogroup.com.au

E&EO © Thermogroup 2020

Contents

Product Checklist	4
Installation Do's & Don'ts	5
Installation Summary	6
Installation Checklist	7
Testing Procedure	8
Mat Alarm Explained	9
Insulation Information	10
Insulation Installation	11
Thermoscreed Installation	12
Operation of Underfloor Heating	17
FAQ's	17
Warranty Information	18
Customer Handover Form	19
Technical Specifications	20
Contact Us	20

Products Checklist

Thermoscreed loose wire heating cable



Thermoscreed is a versatile heating cable designed for installation in the screed layer of new builds or renovation projects. It creates an energy efficient heating system by warming the screed to create a slow release thermal mass. Suitable for use with sand and cement, anhydrite and flow screeds of 20-100mm thick.

Fixing tape



A 50m roll of fixing tape is included with all Thermoscreed kits as the standard fixing method for use on any substrate.

Thermotouch thermostat



Thermoscreed is compatible with all the Thermotouch controllers. Options available include manual, fully programmable single and dual controllers.

Thermoscreed T kits include the 5220A thermostat.

Mat alarm



The 6025 mat alarm is included in all Thermoscreed underfloor heating kits. This alarm is designed to be connected to the Thermoscreed cable while the screed is being poured to alert of any damage.

This does not eliminate the need for conducting the resistance tests as stated in this installation guide.

Floor sensor and flexible conduit



The floor sensor is a small probe that is designed to be installed at the same level as the underfloor heating to measure the accurate floor temperature. This is designed to be housed in the flexible conduit provided to allow for replacement if required.

Please note: These are located in the thermostat box beneath the thermostat. The floor sensor is coiled on the inside of the flexible conduit.

Econoboard insulation boards (optional)



Econoboard insulation boards provide an insulated, prepared surface for the installation of an electric underfloor heating system. It is recommended to install insulation boards directly below the heating system to reduce running costs and increase response times.

Coated and Uncoated boards are available in a 6 or 10mm thickness.

Galvanised fixing profile (optional)



A 25m roll of galvanised steel profile can be mechanically fixed to timber or concrete substrates. Allow 1m of fixing strip per 6m of heating cable. This allows for quick and easy installation through set cable spacing. Please note this can not be fixed to a waterproofed substrate.

In screed cable mesh (optional)

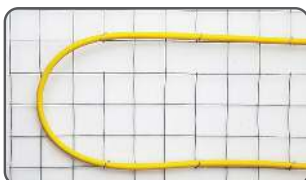

A 6m² roll of loose lay mesh which is designed for loose laying over a waterproof substrate. This provides a easy to fix to mesh and adds rigidity to the screed.

Installation Do's & Don'ts



You must ensure that all the yellow heating cable and the entire cold tail connection (the join between the heating element and the flexible power supply lead) is fully encapsulated in flexible, cement based screed compound.



Please ensure that the end termination (the join at the end of the heating cable) is also fully encapsulated in screed compound.



The cold tail joint and end termination must not be placed into a cut out of insulation or substrate and covered with tape. This can cause the cable to overheat and fail over time.



The entire heating element (everything that is yellow) must be encapsulated in a flexible, cement based screed compound.

Do's

- ✔ Ensure the electrical circuit is protected by a suitably rated RCD and complies with local regulations
- ✔ Ensure the sensor conduit is positioned between 2 runs of heating cable in a representative area of the floor
- ✔ Make sure all the heating cable and cold tail connections are fully covered in a layer of flexible, cement based screed
- ✔ Take care to ensure all joins in the Econoboard are as flush as possible, using reinforcing tape if necessary
- ✔ Take care to ensure all electrical work complies with current electrical regulations
- ✔ Locate the thermostat in accordance with the current guidelines
- ✔ Read this document in conjunction with instructions for associated accessories (e.g. thermostats)
- ✔ Ensure test procedures A, B & C are carried out, this is essential for completion of the warranty
- ✔ Install conduit in accordance with the instructions on page 13 to facilitate the replacement of the sensor probe if required
- ✔ Follow manufacturers recommendation for all associated products such as screeding compound
- ✔ Protect the heating cable during installation, as this is when it is most prone to damage
- ✔ Keep foot traffic to a minimum
- ✔ Install a suitably rated contactor/snubber if required
- ✔ Take care not to cut or nick the heating element
- ✔ Make sure that the fixing tape is tucked tightly around the cable when fixing to the substrate. Bridging the cable will leave air pockets which can cause the cable to burn out

Don'ts

- ✘ Cut or shorten the yellow cable under any circumstances! This will cause a faulty circuit and potential fire hazard
- ✘ Place the cold tail connection or end termination in a recess in the floor or insulation boards and cover with tape. This causes air pockets and leads to cable failure
- ✘ Place the cold tail connection in the conduit. The entire connection needs to be fully encased in a cement based substance
- ✘ Position temperature sensor near pipes, external doorways or other temperature influencers
- ✘ Lay insulation on top of the underfloor heating (UFH) or a dusty substrate. Insulation on top of UFH will reflect all the heat emitted back into the substrate
- ✘ Wire multiple cables in series to the thermostat
- ✘ Turn on system until adhesives and screed is fully cured
- ✘ Leave boxes or furniture on heated flooring
- ✘ Strain or bend the cold tail or end termination at any point
- ✘ Allow the heating cables to touch or cross over each other
- ✘ Allow excessive traffic of any kind over the cable
- ✘ Place tools, buckets of glue, stacks of tiles or anything heavy over the cable
- ✘ Place any product over the floor covering that has a tog rating higher than 2.5
- ✘ Place bean bags, cushions or fixed furniture over the heated floor covering
- ✘ Turn on the heating cable or mat while it is rolled up or before it has been covered by a screed
- ✘ Proceed with installation if the tested resistance is not within -5% to 10% of the stated resistance

If you are unsure or need any help, please call our team on 1300 989 464

Installation Summary

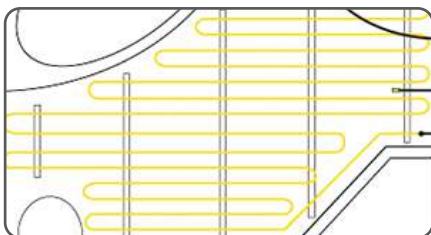

1. Plan out the installation

Determine the location of the thermostat and floor sensor, calculate the available floor space (excluding under floor mounted fixtures) and calculate the required cable spacing. Check you have all the required components. See details on page 4.



2. Rough in prior to sheeting walls

Install two 20mm conduits with sweeping bends at the thermostat / floor sensor position. Insert the supplied flexible conduit into the one conduit and out into the floor. Insert the floor sensor probe into the flexible conduit. See more details on page 13.



3. Clean the floor

Ensure the substrate is clean and free from any dust and debris. It is recommended to vacuum and mop the substrate.

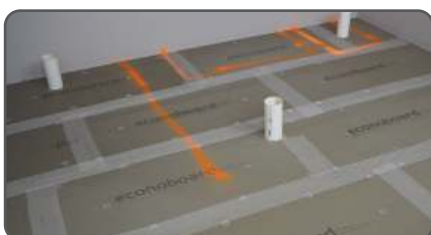

4. Install Econoboard insulation (Optional)

Glue down the uncoated Econoboards to a concrete substrate or screw down (with washers) the coated Econoboards to a timber substrate. See more details on pages 10-11.



5. Conduct test no. 1

Test the floor heating as per details on page 8 and record the results on page 19.

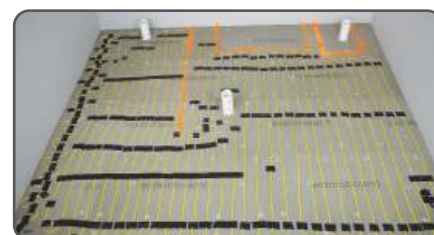

6. Lay out the Thermoscreed cable

Run the heating cable back and forth throughout the room using the spacing calculated and fix in position using the tape provided.

NEVER CUT THE YELLOW CABLE.



7. Secure heating cables in place

Once all the cables are fixed into position go back and add additional strips of tape to ensure the cable is lying flat across the entire floor and the tape is tucked firmly around the heating cable with no air pockets.



8. Conduct test no. 2 and wire up the mat alarm

Test the floor heating as per details on page 8 and record the results on page 19. Wire up the mat alarm to the end of the black cold tail according to the instructions on page 9.

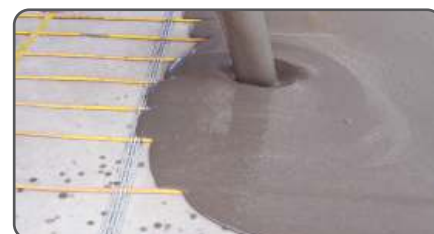

9. Screeding over the heating

Take images of the installed cables before screeding. Cover the heating cables with a flexible sand and cement screed.

See more details on page 16.



10. Conduct test no. 3

Test the floor heating as per details on page 8 and record the results on page 19 before the floor finish is laid.



11. Wire up the Thermostat

Wire up and mount the thermostat according to the wiring diagram and installation details in the thermostat instruction guide.



12. Complete the customer handover form

Ensure the details are complete on the customer handover form (page 19) and pass this onto the client for online warranty registration.

Install Checklist

Before you start

- Run the power feed to the thermostat position
- Read and understand the installation guide in full
- Read and understand the test procedure
- Install two conduits (for the cold tail and floor sensor) from the thermostat position into the floor
- Feed the supplied flexible conduit down one of the conduits and out into the floor
- Use a contactor/snubber if required
- Calculate available floor space and double check the cable is the correct size for the room
- Calculate the correct cable spacing for the length of cable and available floor space

Econoboard insulation (Optional)

- Identify substrate and correct insulation required
- Calculate how many boards you need
- Ensure the substrate is clean and level
- Install insulation according to the relevant guide

Laying the Thermoscreed heating system

- Test the resistance of the heating cable and record results - Test A
- Create a cable spacer template the size of the calculated spacing
- Lay out the heating cable using the spacing calculated
- Leave a gap of 50-100mm between the cable and the walls
- Check the cold tail will reach the thermostat position
- Push the sensor probe to the end of the conduit
- Keep the cap in the end of the floor sensor conduit
- Feed the cold tail up wall to the thermostat position
- Ensure the cold tail connection is not in the conduit
- Tape cables down using tape provided
- Test the resistance of the heating cable and record results - Test B
- Wire up the mat alarm
- Take photographs of the completed install
- Cover with a sand and cement screed

After screeding the floor

- Test the resistance of the heating cable and record results - Test C
- Wire up the thermostat to a RCD
- Connect wiring in accordance with the relevant wiring diagram
- Complete and sign the customer handover form
- Give the customer a completed copy of the customer handover form
- Give the customer a copy of the proof of purchase
- Give the customer a copy of the thermostat instructions
- Wait until glues/screeds are fully cured before turning the floor heating on

Important Testing Procedure

Thermoscreed heating cables must be properly tested before installing. To ensure no damage has occurred the cables need to be tested again after the floor heating has been laid and again once the floor has been screeded. To perform these tests, you will need a multimeter and a meggar. Results of the tests need to be recorded on the customer handover form (page 19) in order to complete the warranty registration.



Heating cable resistance test

Connect a multimeter, set for resistance measurement between the live and neutral power leads. Record the results on page 19. If the measured resistance falls outside a tolerance of -5% to +10% it may mean the cable is damaged or the multimeter is not set correctly.

Continuity between earth and conductors

The conductor cables are separated from the earth cable by an insulator. Verify that there is no contact between the earth and the conductors by connecting a multimeter, set to continuity between the earth and both conductors. Record results on page 19.



Insulation resistance test

This test will detect very small holes in the insulating layer that separates the conductors from the earth. These small holes are not usually detected by the continuity test because they are not necessarily short circuits.

Connect a meggar calibrated to 500V to one of the conductor cables and the earth. If there is no current leakage, the insulation resistance between the power leads and earth must be equal to or greater than 200M Ω . Repeat for the 2nd conductor cable. Record results on page 19.



Floor temperature sensor testing

Connect a multimeter to the two conductors of the floor temperature sensor probe. Measure the resistance at room temperature. The resistance of the sensor should be 8K Ω at 20°C. Record results on page 19.

The ambient temperature will affect the resistance readings of the floor heating cable and the floor sensor. Both the floor heating cable and floor sensor resistance have been tested at 20°C. If the ambient temperature is lower than 20°C the measured resistance will be higher than the stated resistance and if the ambient temperature is higher than 20°C the measured resistance will be lower than the stated resistance.



Scan here to view the video showing how to perform a full testing procedure

If you are unsure about any of the tests or results, please contact technical support on 1300 989 464 before proceeding

Mat Alarm Explained

The mat alarm is a small white unit that is used to monitor the integrity of the cable during tiling or screeding.

PLEASE NOTE: The use of the mat alarm does not replace the need for the full resistance tests as outlined on the previous page at any stage throughout the installation.

Do not proceed with tiling/self-levelling/screeding if the resistance reading is not within -5% to +10% of the values published on the cable labels. Once the tests have been completed you will need to install the mat alarm.

The mat alarm is there to safeguard against any damage to the heating element during the screeding or self-levelling process. It gets connected to the end of the cold tail. The monitor is designed to monitor the cables individually however by making a temporary 'series' connection of multiple cables it can monitor up to three cables at a time

1. Switch the unit on and the alarm should sound, and the red light will be lit. The alarm will sound when the cables are not connected.

2. When the cables are connected the green light will be lit. If the green light goes out, please replace the batteries before continuing.

3. Make sure the cables to be monitored are not connected to a power source. Wire up the cold tail to the mat alarm as per the photo opposite and details below.

4. Set the switch to the 'ON' position and the green light will indicate that the monitor is operating.

5. Hang or place the monitor where it can be seen and heard during installation.

6. A red light and alarm indicates cable damage or disconnection of cables from the monitor. Check connections and the integrity of the heating cable before continuing with the installation.

7. If damage to the cable is suspected please contact the technical helpline on 1300 989 464.

For a single element

Terminal 1: Neutral

Terminal 2: Live

Terminal 3: Earth

For two elements

Terminal 1: Neutral from cable 1

Terminal 2: Live from cable 2

Terminal 3: Earth from both cables

Twist together the live from cable 1 and the neutral from cable 2 to complete a series circuit

IMPORTANT!

Multiple cables are connected to the alarm in series, for monitoring purposes only. When completing the final circuit, multiple cables must be connected to the thermostat in parallel.



Mat alarm with single element



Mat alarm with two elements wired in series



Scan here to view the video on mat alarm explanation and wire up

Insulation Information

Econoboard Insulation is essential for an energy efficient electric underfloor heating system. A layer of Econoboard will help prevent heat loss into the substrate and ensure faster heat-up times for the underfloor heating.

Econoboard Insulation comes in both coated and uncoated options. Econoboard Coated boards consist of a high-density extruded polystyrene core with a polymer modified fibre reinforced cement coating on both sides, whereas the Econoboard Uncoated boards are made from an XPS extruded polystyrene foam. Using the correct type of insulation board is vital for the correct floor build-up and optimal performance of your heating system.

Uncoated Econoboard boards are designed to be used over a solid, stable substrate such as a concrete substrate or cement sheeting while Coated Econoboard boards are designed for use on a timber substrate as the fibre reinforced cement coating adds strength and rigidity to the floor build-up.

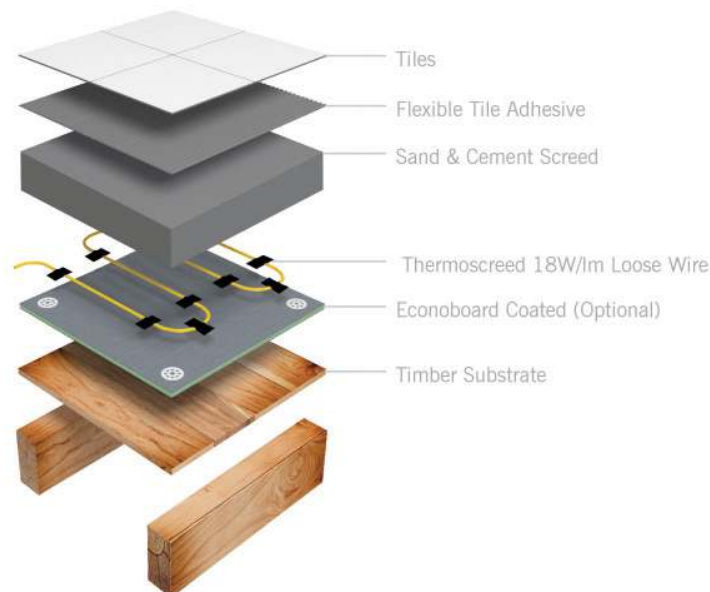
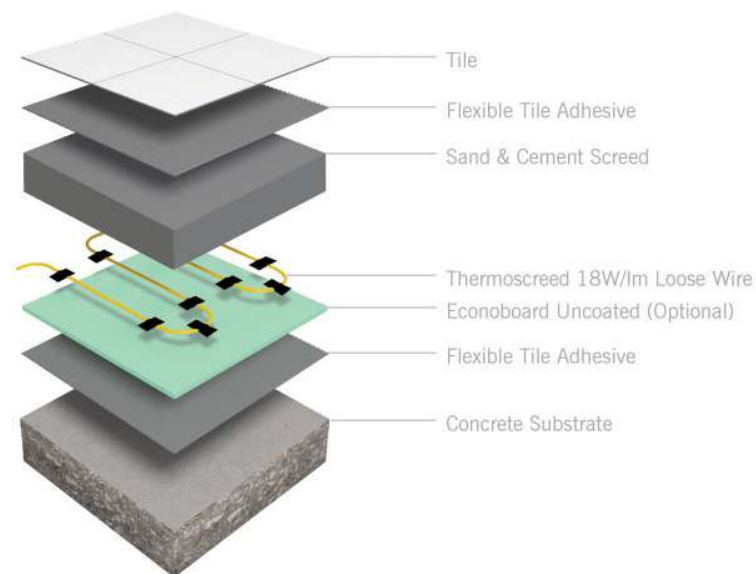

Insulation Installation

The Econoboard Insulation boards are installed onto the substrate (either above or below the waterproofing) in an offset brick pattern. The Coated boards are fixed down to the timber substrate using Econoboard fixing washers (6016) and screws (6020) and Uncoated boards are glued down with a full bed of tile adhesive.

Installing Uncoated Econoboard

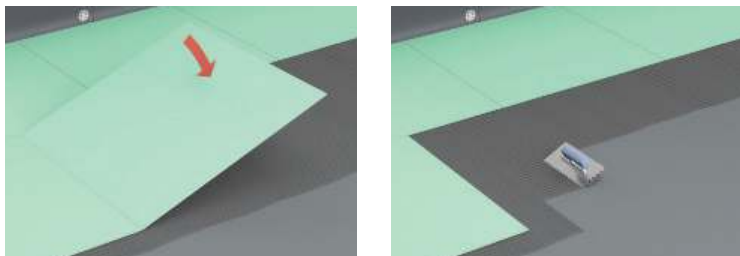

1. Measure your floor space and calculate how many boards you will need using the simple formula below

$$\begin{aligned} \text{A single board} &= 1.2\text{m}^2 \times 0.6\text{m}^2 = 0.72\text{m}^2 \\ \frac{\text{Floor space (m}^2\text{)}}{0.72\text{m}^2} &= \text{Number of boards} \end{aligned}$$

2. Cut the Econoboard Uncoated boards to size to suit your room layout. Econoboard Uncoated can be cut very easily using a sharp blade or wood saw. Please take appropriate care when using sharp tools.
3. Ensure your substrate is secure, clean and free from dust and loose particles. Mix flexible tile adhesive in accordance with manufacturer instructions and spread using a notched trowel.
4. Lay the Econoboard onto the adhesive in an offset brick pattern taking care to squeeze out any air pockets in the adhesive. For a more secure finish make sure all boards are flush and tape over the joins using reinforcing tape (6015).

Installing Coated Econoboard

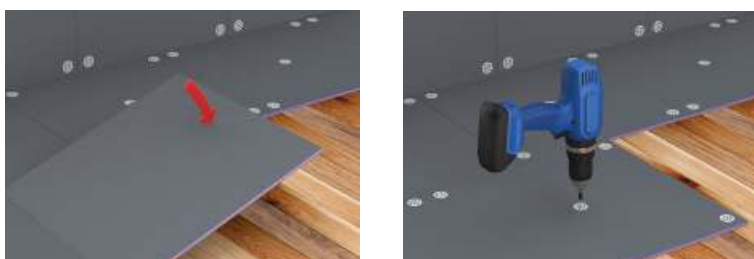

1. Measure your floor space and calculate how many boards you will need using the simple formula shown above.
2. Cut the boards to size to suit your room layout. Econoboard Coated boards can be cut very easily using a sharp blade or wood saw. Please take appropriate care when using sharp tools.
3. Ensure your substrate is secure, clean and free from dust and loose particles. Set out your cut boards onto the area in an offset brick pattern. Boards need to run in the opposite direction to the floorboards. Fix into position using fixing screws (6020) and washers (6016) at 300mm centres (10 washers per board).



Scan here to view the video on how to install Econoboard Insulation

Thermoscreed Installation

Calculate spacing & prepare room for heating

Measure your room, if you don't already know the dimensions, and make a note of the available floor space excluding any obstacles or fixtures you might have such as sanitary ware, furniture or drainage. The Thermoscreed heating system is safe to be installed in the shower area providing that it is fully encased in the screed layer, however do not start or end in the shower.

Allow between 180–220W/m² based on available floor space to calculate required length of cable. Correct spacing is essential for an efficient system. Ensure Thermoscreed cable is spaced evenly. Use the below cable spacing formula to calculate the ideal cable spacing.

$$\frac{\text{Available floor space (m}^2\text{)} \times 100}{\text{Kit length (m)}} = \text{Cable spacing (cm)}$$

Example spacing calculation:

Output required: 200W/m²
Heated area: 4m x 2.5m = 10m²
Total output: 10m² x 200W/m² = 2000W
Stock number: Stock No. 3061 = 2100W (116LM)
Cable spacing: $\frac{10 \times 100}{116} = 8.6\text{cm spacing}$

Load calculation:

Use the below formula to work out the overall current draw for your Thermoscreed system. If this value is over 16Amps (A) you will need to have a contactor and snubber installed by a qualified electrician. Call our technical help line on 1300 989 464 if you have any questions.

Sum of individual heating cables loads = Total load (W)

Calculate the current draw in amps (A) by dividing the total load (W) by the working voltage

$$\frac{\text{Total load (W)}}{240 \text{ (V)}} = \text{Total current draw in amps (A)}$$

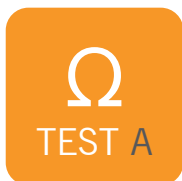

Test the resistance (using instructions on page 8) of the heating cable prior to starting the installation. Compare the tested resistance to the correct resistance of the cable and ensure this is within -5% to +10%. Record the result on the customer handover form (page 19).

It is recommended to install a layer of Econoboard insulation below the heating to improve the efficiency of the heating by preventing downward heat loss and reducing heat up times. See details on page 10-11.

If not using Econoboard, a suitable floor primer product can be used to prime the floor prior to the installation of the underfloor heating. The primer helps the tape to adhere to the substrate. Please follow the manufacturers instructions on the suitable use of the floor primer.

Make sure your substrate/insulation is clean and dust free before installing your heating cable. Measure and mark all fixtures in the room.

Thermoscreed Installation

Position and install conduit and floor sensor

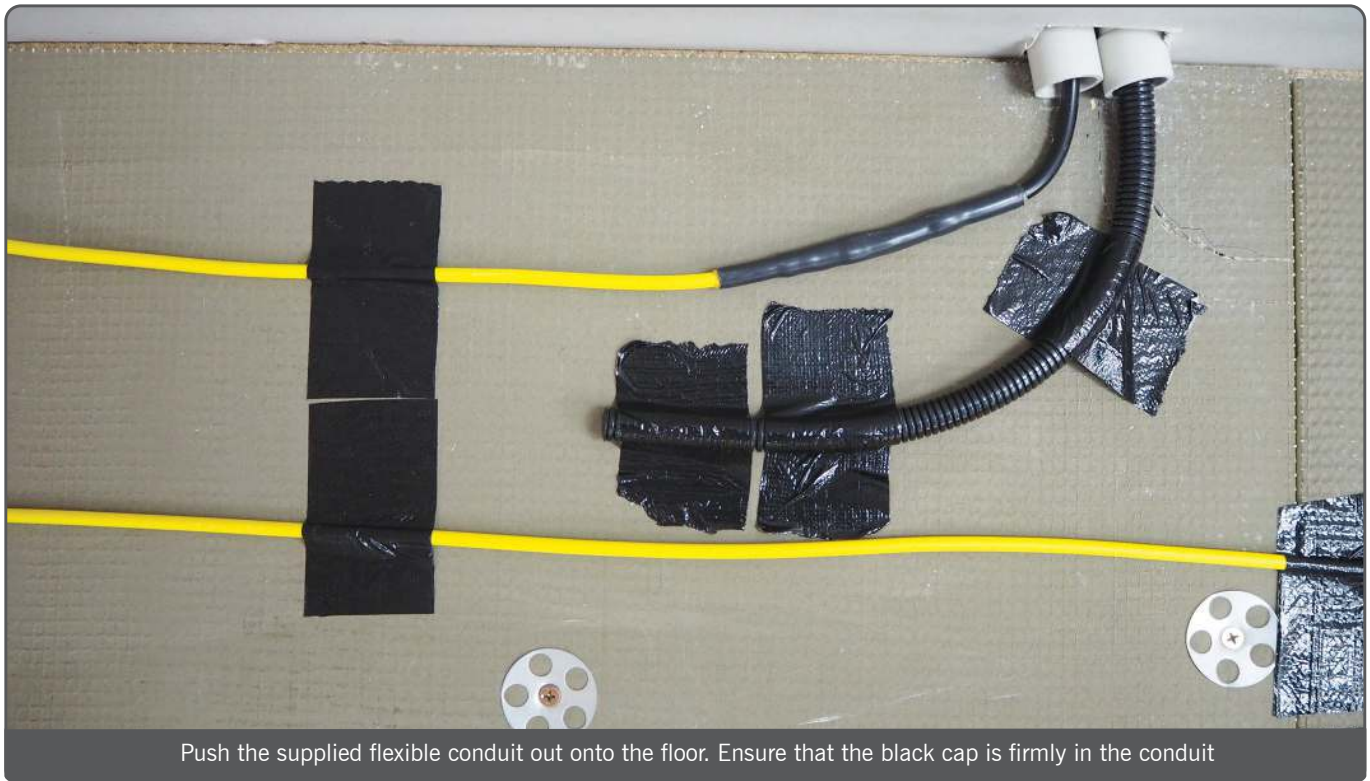

Run the 240V mains power feed to the thermostat position. Ensure the electrical circuit is protected by a suitably rated RCD (residual current device). Install a suitably rated contactor if required. Install the electrical plate for the thermostat in the desired position. Please note the Thermotouch 7.6iG thermostat needs to be mounted portrait and the Thermotouch 4.3dC thermostat has the option of portrait or landscape mounting. Install two 20mm conduits with sweeping bends from the thermostat to the floor prior to sheeting the walls. The one conduit will house the flexible floor sensor conduit and the second conduit is for the cold tail(s).

It is important not to position the sensor conduit near any temperature influences (such as water pipes or doorways) or in a place where furniture or rugs might be placed over the sensor as this will affect the accuracy of the temperature reading. Feed the flexible conduit down one of the 20mm conduits and out onto the floor. Ensure the black cap is firmly in the end of the conduit, this is to ensure no screed enters the conduit.

The floor sensor conduit provided is to facilitate the sensor replacement if ever needed without the need to remove tiles or the floor covering. Now feed the sensor probe cable down into the conduit ensuring it is pushed right to the end as this will help to provide the most accurate reading.

The sensor probe cable can be shortened or lengthened. If you need to cut the sensor probe you must only cut the end with the exposed wires not the end with the plastic probe. The sensor can be extended, to a maximum of 50m, using a twin core 1mm flex.

The cold tail can also be shortened or lengthened. Cold tails can be extended using a twin core and earth electrical flex, suitably sized to take the load of the underfloor heating system.

Feed the cold tail up the second 20mm conduit to the thermostat position. The heating cable is a single ended product so there is no additional cold tail to return to the Thermostat position.

Do not install the heating under any fixtures or solid based furniture.

Do not place the cold tail connection or end termination in the wall/floor cavity, in the conduit or in a recess in the floor/insulation boards covered with tape. This causes an air pocket which voids the warranty and leads to cable failure.

Leave 50-100mm space between the wall and the heating cable.

Thermoscreed Installation

Fix cables in place – standard fixing method (fixing tape)

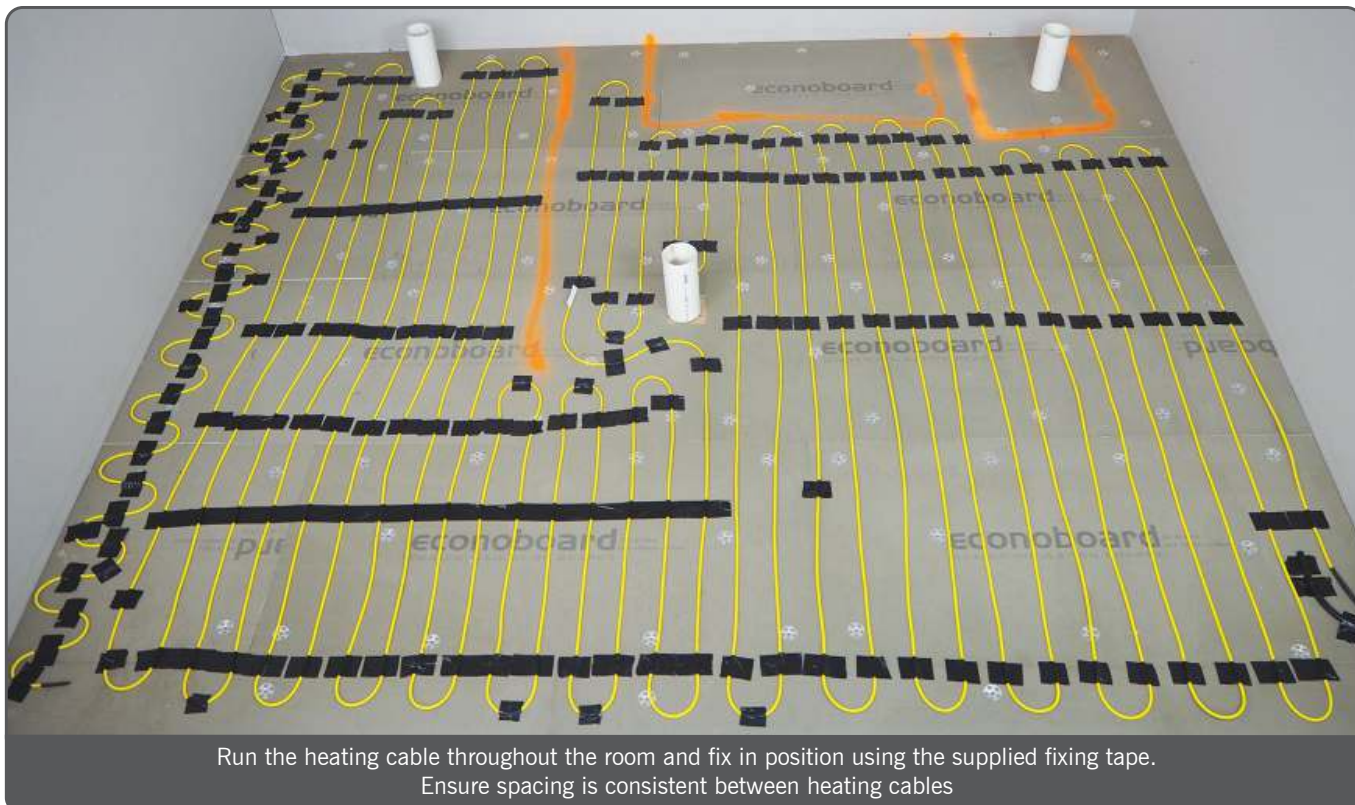

Beginning from the Thermostat position, start running the heating cable throughout the room using the cable spacing calculated on page 12 and fix in place using strips of cloth weave tape.

To keep a consistent cable spacing, cut a template to the desired spacing. Continue to run the cables out across the room fixing into position as you go.

When taping down ensure that the tape is pressed tight around the cable to ensure the cable is fully encased and there are no air pockets around the cable that could potentially lead to cable damage. Do not run long lengths of tape along the runs of heating cable. The tape is designed to fix the cable in position not to cover the heating cable.

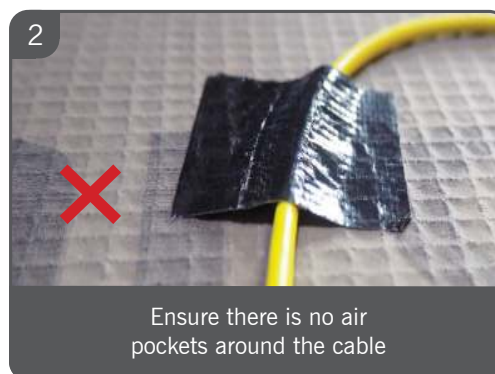
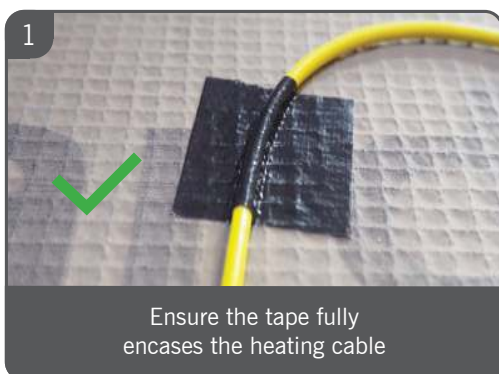

When approaching objects such as a floor waste arrange the cable around the fixture to ensure consistent cable spacing from the fixture.

There is a halfway mark label on the cable, when you reach this point take a moment to check that you are halfway through the room. If not recalculate the spacing and adjust slightly, as necessary.

Once all the cables are fixed into position it is recommended to go back and add additional strips of tape to ensure the cable is lying flat across the entire floor. Take photographs of the completed install for warranty purposes.

Thermoscreed Installation

Alternative fixing method 1 – In screed mesh

Using the in screed mesh ensures there is no penetration or adhesion to the substrate, so is especially suited to a waterproofed substrate. Firstly, lay out the mesh across the room and cut to length. Continue to run the mesh runs alongside one another to cover the entire floor joining the runs by clipping the wire on the edge and wrapping it around the run of mesh alongside to form a complete mesh grid over the entire floor. Press or bend the mesh slightly to allow it to lie flat on the floor.

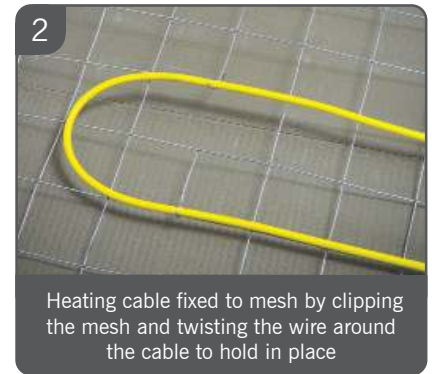
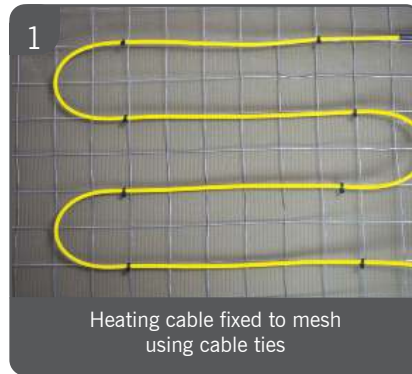

Now using the cable spacings calculated on page 12, start at the thermostat position, and run the cable out along the mesh. The cable can be fixed to the mesh by either using cable ties (Image 1 above) or by cutting the mesh at intervals and twisting the wire around the cable to hold it in place (Image 2 above). Continue this across the room to complete the cable and cover the available heating area. Make sure where the mesh is cut there is no sharp points of wire that can penetrate the waterproofing or heating cable. The floor is now ready for screeding.

Alternative fixing method 2 – Galvanised fixing profile

When using galvanised fixing profile allow 1m of fixing strip per 6m of heating cable.

The fixings strips should be laid at a right angle to the Thermoscreed cable and spaced in intervals of approx. 750mm apart. Allow a 100mm space from the edge of the fixing profile to the wall. Starting from the thermostat position begin to meander the Thermoscreed cable.

The cable should run up and down the room at 90° to the fixing profile. It is essential to have an even spacing between each run of cable to avoid uneven distribution of heat or hot/cold spots. Follow the spacing calculations made on page 12. Lock the heating cable in place following the diagram below.

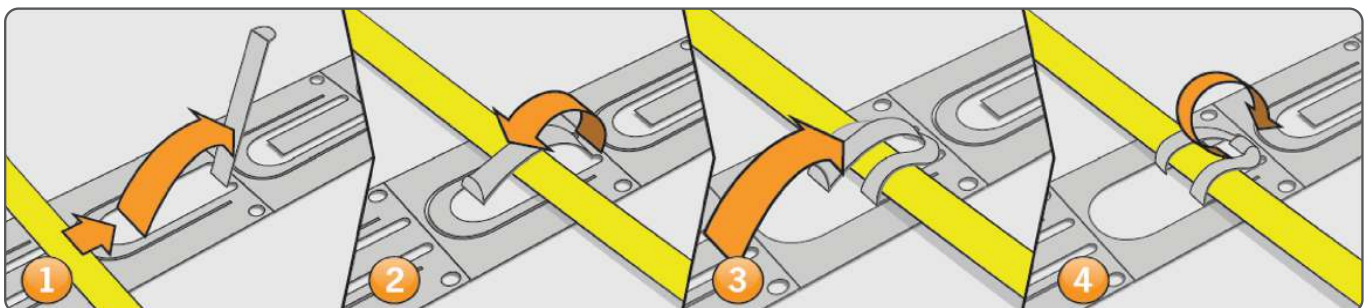

Scan here to view the video on how to install the Thermoscreed Heating System

Thermoscreed Installation

Screed over the heating cable



Test the resistance (using instructions on page 8) of the heating cable once the heating cable has been installed and the floor is ready for screeding. Compare the tested resistance to the correct resistance of the cable and ensure this is within -5% to +10%. Record the result on the customer handover form (page 19).

Once Test B is complete the floor is ready to be screeded. The entire floor heating cable (including the entire cold tail connection and the end termination) needs to be encased in a flexible, cement based compound (No specific brand required).

Wire up of the Thermostat



Test the resistance (using instructions on page 8) of the heating cable once the screed has been laid. Compare the tested resistance to the correct resistance of the cable and ensure this is within -5% to +10%. Record the result on the customer handover form (page 19).

Once test C is complete the floor finish can be installed. In some cases, it may be necessary to install other floor finishes such as laminate, engineered board, vinyl or carpet over the Thermoscreed system. Before doing so you should check with the flooring manufacturer that your desired floor finish is suitable for use with an electric underfloor heating system and ensure the thermostat is set to limit the temperature to the manufacturer's maximum temperate guidelines.

To allow for the adhesive to fully cure you must wait two weeks, unless otherwise stated by the manufacturer, before turning on the heating system.

Wire up of the Thermostat

The thermostat must be installed by a qualified electrician in accordance with the current local electrical regulations. The installation and wiring of each thermostat model is different. Consult the instruction guide supplied with the thermostat for wiring diagram and installation details. When wiring up multiple mats to a single thermostat ensure the mats are wired in parallel.

Thermostats should be connected to a single phase mains supplied via an RCD. The RCD rating is dependent on the overall load of the system.

Check the thermostat installation guide for maximum switching loads. If the system load exceeds the maximum load of the thermostat a suitably rated contactor will need to be installed



Scan here to view the video on how to wire up the thermostat

Complete the customer handover form

Once the installation is complete the installer needs to ensure the customer handover form (page 19) is complete. This completed form along with photo(s) of the layout of the heating and a proof of purchase needs to be presented to the end user/homeowner to allow for the completion of the lifetime warranty registration. A warranty will not be granted unless this information has been completed in full and submitted via the online form at www.thermogroup.com.au/warranty. The homeowner needs to keep a copy of the handover form in case of a warranty claim.

To allow for the screed and tile adhesive to fully cure you must wait two weeks, unless otherwise stated by the adhesive/screed manufacturer, before turning on the underfloor heating system.

The heating may be slow to react at first especially if installed on a new slab. When turning the floor heating on for the first time, we recommend setting the floor temperature at approx. 18°C and building up by 1°C per day until the desired temperature is reached.

What should I do if I have left-over heating cable?

You should always measure the room accurately and choose a system that covers the available heating area. If you do have extra cable you can reduce the spacing between the runs of cable (min. spacing 50mm) run it around the edge of the room, or in the shower as long as it is covered by a cement based flexible tile adhesive or screed.

Can I cut the heating cable if I have excess?

No - never. Cutting the heating cable will alter the resistance and cause the element to overheat. If you cut the cable by accident, please call our technical helpline for assistance. Cutting the element will void the warranty.

Can I join two or more heating cables to fit a larger area?

No, the heating cables cannot be joined together however two or more can be connected in parallel to one thermostat. When connecting multiple cables you need to ensure that the total load does not exceed the max load of your thermostat. If the load does exceed the load of the thermostat a suitably rated contactor will need to be installed.

What happens if it goes wrong or breaks under my floor?

There are no moving parts to an electric underfloor heating system and cable failures are extremely rare, if installed correctly. A damaged cable can usually be located and repaired with minimal disruption.

How long will it take for the floor to heat up?

Every situation is different due to the insulation value of the property, type of flooring used and the level of insulation below the heating system. The first time you turn the heating system on it will take longer to heat up. An In Screed system will take longer to heat up than an Undertile system however in turn will retain the heat for longer.

Can I turn the heating on to make sure it heats up before the floor is screeded?

No. The heating cable systems need to be enclosed in a cement layer to help spread the heat. Turning on the heating before the cement layer is applied will cause the cable to overheat and burn out. The heating cable needs to be tested by a qualified electrician to ensure no damage has occurred during installation. See testing details on page 8.

Can you walk on the installed heating cables before the tiles are laid?

Whilst the cable is durable and will handle foot traffic we recommend reducing walking on unfinished floor surfaces to a minimum as a precaution. Avoid putting heavy objects with sharp edges (such as buckets of tile glue) down on the cable.

Is the underfloor heating installed above or below the waterproofing?

As the floor heating is IP68 rated it can be laid above or below the waterproofing. In most inscreed applications the waterproofing is done on top of the screed layer. Please note the waterproofing cannot be installed directly over the heating cable as the heating cables need to be encased in a flexible, cement-based compound.

Does the floor sensor have to be installed in the conduit?

We recommend the use of a conduit for the floor sensor so that in the event of a floor sensor failing or the thermostat being upgraded, the floor sensor can be replaced without damaging the floor covering. If this is not possible, we recommend installing a second floor sensor as a spare.

Warranty Terms & Conditions

The Thermogroup Lifetime Warranty guarantees Thermoscreed Underfloor Heating to remain free from defects in workmanship and materials under normal use and maintenance, and is guaranteed to remain in full working order subject to the conditions and limitations below:

Thermoscreed Underfloor Heating is guaranteed for the Lifetime of the floor covering under which it is originally fitted subject to the following conditions. Please pay attention to the exclusions listed at the end of this warranty statement.

Thermogroup Lifetime Warranty applies:

1. Only if the product is registered, and the registration information is received and documented by Thermogroup, within 60 days after install. You can register your product by completing the form online at www.thermogroup.com.au/warranty. Proof of purchase must be presented to make a claim, so please ensure that you keep a copy of both your invoice and purchase receipt in a safe place. Such invoice/receipt should clearly state the model that has been purchased and be in legible condition so as to aid in identifying the system.

2. Only if the Thermoscreed Underfloor Heating has been properly earthed and protected by a Residual Current Device (RCD) at all times.
This warranty does not cover any thermostats as these are covered by a separate 3 year warranty from the date of purchase.

All Thermogroup warranties become void if the floor covering under which the Thermoscreed Underfloor Heating is originally fitted, is damaged, lifted, replaced, repaired or covered with additional layers of flooring. The Thermogroup Lifetime Warranty does not cover accidental damage, including but not limited to damage caused to the cable by lifting, replacing or repairing the original covering.

The warranty period starts on the date of purchase, but the registration is only confirmed when the online warranty form has been complete and the registration details are submitted to the online warranty database in full, checked by Thermogroup and written confirmation is issued. Should it be required, Thermogroup will arrange for the underfloor heating loose wire element to be repaired or (at the discretion of Thermogroup) have parts replaced free of charge. If a fault is proved to be a manufacturing defect, Thermogroup will make good the floor covering to the original condition.

The Thermogroup lifetime warranty does not cover damage caused during installation, tiling or installation of any floor covering. Therefore, it is important to adhere strictly to the installation guide provided and follow the full test procedures detailed in this document before, during and after installation. Failure to do so will result in a void warranty. Thermogroup are, in no event, liable for incidental or consequential damages, including but not limited to extra utility charges or damages to property.

Thermogroup are not held accountable for:

1. Damages or repairs as a result of incorrect installation or application.
2. Damages as a result of floods, fires, winds, lightning, accidents, corrosive atmosphere or any other conditions/situations deemed beyond the control of Thermogroup.
3. Use of un-compatible components or accessories.
4. Products installed outside of Australia.
5. Normal maintenance and care procedures.
6. Parts not supplied or designated by Thermogroup.
7. Damages or repair required as a direct result of any improper maintenance, operation or servicing.
8. Failure to power up or start as a result of inadequate/interruption of electrical service.
9. Changes in the appearance of the product that do not directly affect the performance of the product.

Important Notes:

Any repaired Thermogroup underfloor heating element carries only a 5 year warranty. Repairs that are made to rectify any damage other than manufacturing defects are not covered by the Thermogroup warranty. Damage as a result of miss-use, improper installation, use of improper accessories or adhesives or unsuitable substrate conditions are in no event covered by any Thermogroup warranty.

Our goods and services come with guarantees that cannot be excluded under the Australian Consumer Law. For major failures with the service, you are entitled: to cancel your service contract with us; and to a refund for the unused portion, or to compensation for its reduced value.

You are also entitled to choose a refund or replacement for major failures with goods. If a failure with the goods or a service does not amount to a major failure, you are entitled to have the failure rectified in a reasonable time. If this is not done you are entitled to a refund for the goods and to cancel the contract for the service and obtain a refund of any unused portion. You are also entitled to be compensated for any other reasonably foreseeable loss or damage from a failure in the goods or service.

Customer Handover Form

INSTALLER: The installer must complete the full test procedure and complete this page in full and give it to the homeowner to keep in case of a warranty claim.

HOMEOWNER: Use this information to register your Lifetime Warranty at www.thermogroup.com.au/warranty. You must also keep this document for your records in case of a warranty claim.

Room reference	Stock no.	Manufacturer's values	Before installation (Test A)	After cable installation (Test B)	After tile/flooring installation (Test C)
Resistance measurement of the electric heating cable					
Two conductors and earth braid continuity test					
	Infinity (I) or Overload (OL)				
Insulation resistance test between conductor cables and earth braid					
	Equal to or greater than 1 G Ω				
Floor temperature sensor test					

Manufacturers Test Log
<p>To the installer: Fix manufacturer test results label from on the heating mat here. Staple multiples.</p>

Installer Details
Name:
Company:
Email:
Phone:
Address:
Signature:
Date:

Technical Specifications

Stock Code	Area (m ²)	Length (m)	Output (w)	Resistance (Ω)
3050	1.0 – 1.2	11.0	200	264.5
3051	1.3 – 1.7	16.5	300	176.3
3052	1.8 – 2.2	22.0	400	132.2
3053	2.3 – 2.7	27.5	500	105.8
3054	2.8 – 3.2	33.0	600	88.2
3055	3.3 – 3.8	39.0	700	75.6
3056	3.9 – 4.6	45.0	850	62.2
3057	4.7 – 5.6	55.0	1000	52.9
3058	5.7 – 6.8	69.0	1250	42.3
3059	6.9 – 7.6	76.0	1375	38.5
3060	7.7 – 9.4	94.0	1700	31.1
3061	9.6 – 11.7	116.0	2100	25.2
3062	11.8 – 14.4	144.0	2600	20.4
3063	14.5 – 18.3	183.0	3300	16.0

Stock Code	Description	Size	Unit
5418	Fixing Tape	50mm x 50m	Roll
3259	Galvanised Fixing Profile	25m	Roll
3261	In Screed Cable Mesh	6m ²	Roll

Thickness	5.5mm*
Max Temperature	28°C**
Protection Rating	IP67
Warranty	Lifetime on heating cable
Conductor Type	Single Ended
Cold Tail Length	5m

*Cold tail is 4mm thick

**Regulated by a floor sensing thermostat

Actual tested resistance may differ from those listed. Allow a tolerance of -5% to +10% of the resistance specified.

Thermogroup
PO Box 822
19 Ridley Ave
Leeton NSW 2705

1300 989 464
sales@thermogroup.com.au
www.thermogroup.com.au

E&EO © Thermogroup 2020