

Thermonet 200W/m² T Kits

For Installation In Screed Up To 100mm Thick

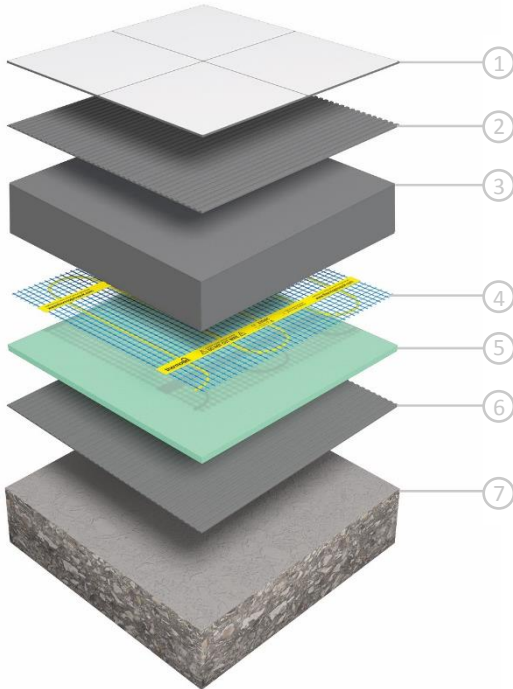

1. Tiled floor finish
2. Flexible tile adhesive
3. Sand & cement screed
4. Thermonet 200W/m² heating mat
5. Econoboard uncoated insulation board
6. Flexible tile adhesive
7. Concrete substrate



Lifetime Warranty

We are so confident of the quality of our German-made Thermonet Underfloor Heating that we give each system a warranty that lasts a Lifetime with 3 year warranty on our Thermostats.



In Screed heating

Suitable for installation in screeds of 20mm to 100mm, and is recommended to be fixed to insulation boards.



TwistedTwin cable on full self adhesive mesh

The unique stress free cable construction creates a longer lasting heating cable with zero electromagnetic field (Zero EMF). The self adhesive mesh speeds up installation by holding Thermonet matting to the substrate for easy self levelling and tile fixing.



Ideal for areas with limited floor space

Thermonet 200Watt mats are ideal for rooms with limited floor space for the heating mat. The 200Watt ensures a high heat output across the floor warming the entire room.



Perfect for high heat loss applications

The high heat output of the 200Watt mats makes them perfect for rooms which are prone to high heat loss. This can be further reduced by adding a layer of insulation below the heating.

Technical Data



Kit Includes: Thermonet 150W/m² Mat, Programmable Thermostat (5220A), Floor Temperature Sensor, Sensor Conduit, Cable Monitor, Installation Guide & Warranty Form.

Width	500mm
Heated Width	430mm
Thickness	3.5mm
Max. Temperature	28°C *
Protection Rating	IP68
Warranty	Lifetime on heating mat
Wattage	200W/m ²
Conductor Type	Singe Ended
Cold Tail Length	5m

*Regulated by floor sensing thermostat



Installation Overview

Thermonet electric underfloor heating mat is quick and easy to install. This overview gives a guide to the basics. Always read the instructions in full before attempting your own installation.

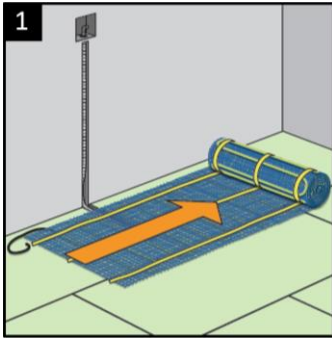

1 Roll out the mesh
The mesh should be laid wire side down

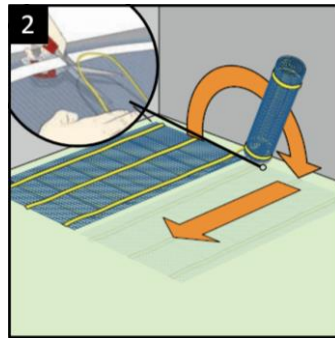

2 Cut the mesh (not the cable)
Turn the mesh 180° and continue rolling

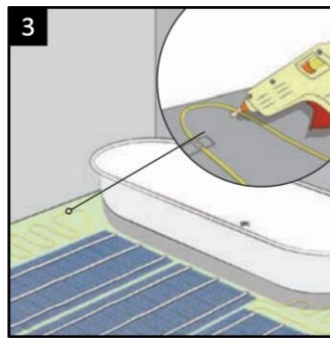

3 Loose run for irregular areas
Remove the cable from the mesh, arrange and stick down

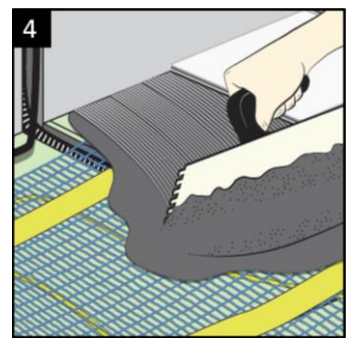

4 Screed & Tile
Lay your screed and then tile on top of the screed layer

This is an illustrative guide only. Read the instruction manual that is supplied with the system in full before attempting installation.

Thermonet Mesh 200W/m² T Kits

Stock Code	Size (m)	Area (m ²)	Output (W)	Resistance (Ω)
112002T	2 x 0.5	1.0	200	265
112003T	3 x 0.5	1.5	300	176
112004T	4 x 0.5	2.0	400	132
112005T	5 x 0.5	2.5	500	106
112006T	6 x 0.5	3.0	600	88
112007T	7 x 0.5	3.5	700	76
112008T	8 x 0.5	4.0	800	66
112009T	9 x 0.5	4.5	900	59
112010T	10 x 0.5	5.0	1000	53
112012T	12 x 0.5	6.0	1200	44
112014T	14 x 0.5	7.0	1400	38
112016T	16 x 0.5	8.0	1600	33
112018T	18 x 0.5	9.0	1800	29
112020T	20 x 0.5	10.0	2000	26
112024T	24 x 0.5	12.0	2400	22





Thermotouch 7.6iG thermostat features a sleek white glass display and an improved 7 day 6 event heating schedule

Easily program 6 heating events (3 on and 3 off) for every day of the week to create an efficient, automatic schedule for your electric underfloor heating system

- 

Designed to control your electric underfloor heating system easily and automatically
- 

Built in ambient temperature sensor and external floor sensor for accurate temperature management
- 

Lock the screen to prevent tampering by holding the up and down arrows for 5 seconds
- 

Design an economical heating schedule for your underfloor heating system that fits your lifestyle
- 

Adjust the temperature manually to boost your underfloor heating until the next scheduled heating event

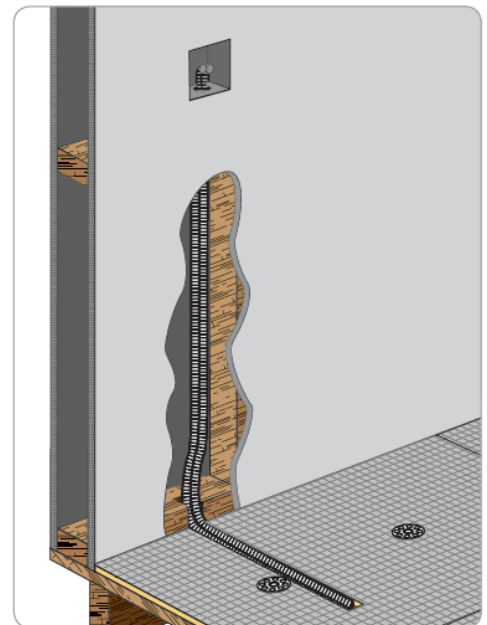

Floor temperature sensor should be installed in a conduit, within a clear area of the floor, and away from any other temperature influences.

Wiring diagram

1. Live – 240V supply
2. Neutral – 240V supply
3. Neutral – Underfloor heating
4. Live – Underfloor heating
5. Earth
6. Floor sensor (not polarity sensitive)
7. Floor sensor (not polarity sensitive)

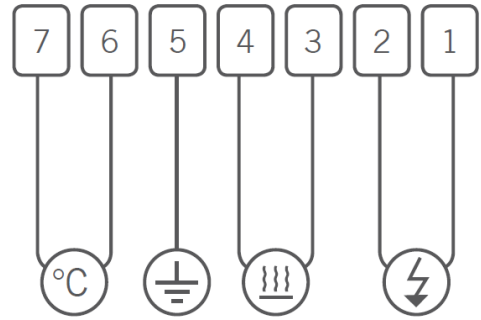

Box contents

- 1 x Thermotouch 7.6iG
- 1 x Installation guide
- 1 x 3m floor temperature sensor probe
- 1 x 2m sensor conduit
- 2 x Fixing screws
- 1 x Portrait mounting plate

Dimensions (mm)

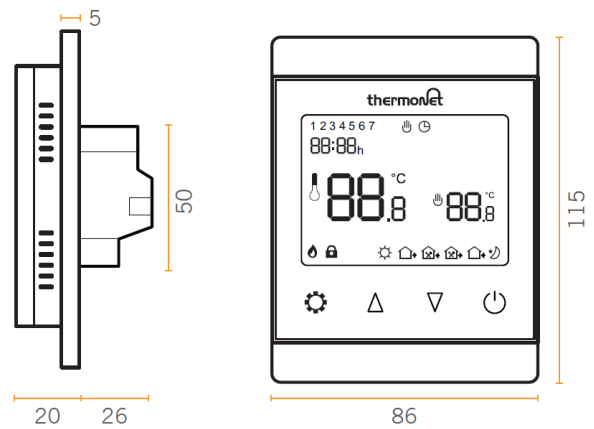

Technical data

Supply voltage	240V 50/60Hz
Maximum load	16A (3600W)
Backup storage	EEPROM (approx. 1 year backup)
Temperature range	5 ~ 80°C (0.5°C increments)
Accuracy	± 0.5°C
Sensor rating	NTC 10Ω @ 25°C
Consumption	2W
Warranty	3 year
IP rating	IP30
Width	86mm
Height	115mm
Depth	46mm (26mm in wall)